

Woodland

Farmhouse Country

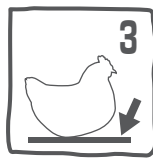

WOODLAND  
BY

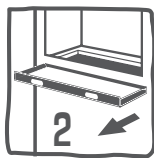
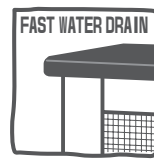

Made in China

Join us!

[www.duvoplus.com](http://www.duvoplus.com)



Writing  
Pet Stories  
Together



Industrieweg 98-100  
9032 Wondelgem | Belgium  
[www.laroygroup.com](http://www.laroygroup.com)

f @laroygroup

## THESE PARTS:

### FASTENERS

(A) 19 pcs -  $\varnothing 3,5 \times 45$  mm



(C) 13 pcs -  $\varnothing 3.0 \times 20$  mm



(E) 21 pcs -  $\varnothing 3.5 \times 22$  mm

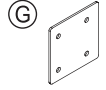

PANEL BRACKET  
(Qty. 3)

(B) 4 pcs -  $\varnothing 3.5 \times 60$  mm



(D) 3 pcs -  $\varnothing 3.0 \times 16$  mm



(F) 13 pcs -  $\varnothing 3.5 \times 35$  mm



### WOOD PIECES

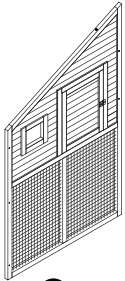

1a

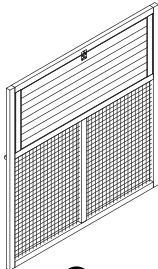

1b

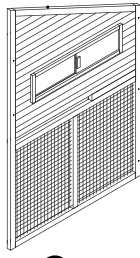

1c

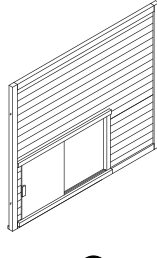

1d

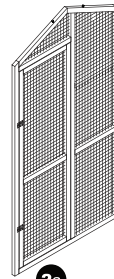

2a

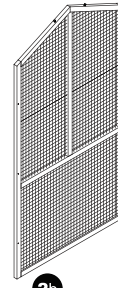

2b

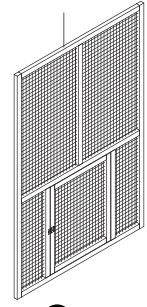

2c

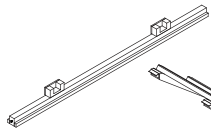

3

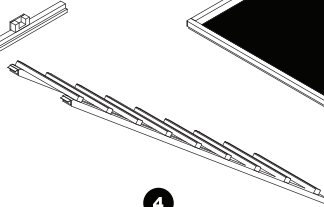

4

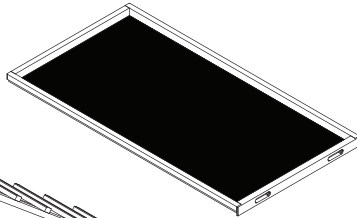

5

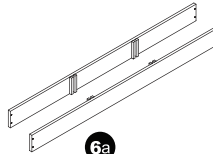

6a

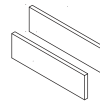

6b

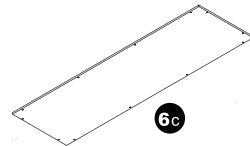

6c

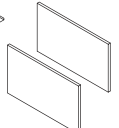

6d

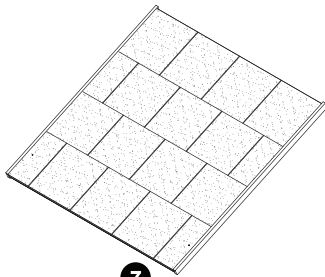

7

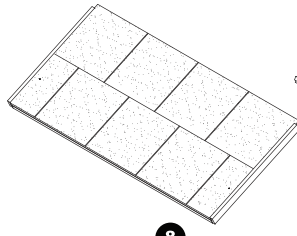

8

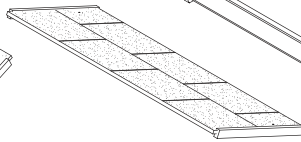

9

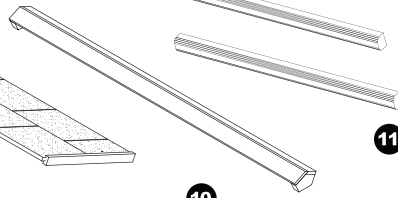

10

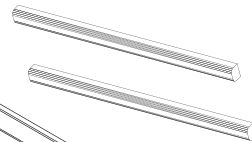

11



12

# Assembly Instructions

\*Use Screwdriver for Assembly

## 1

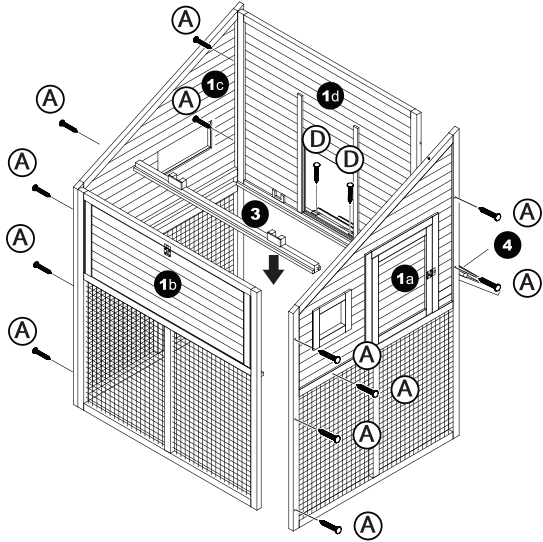

## 2

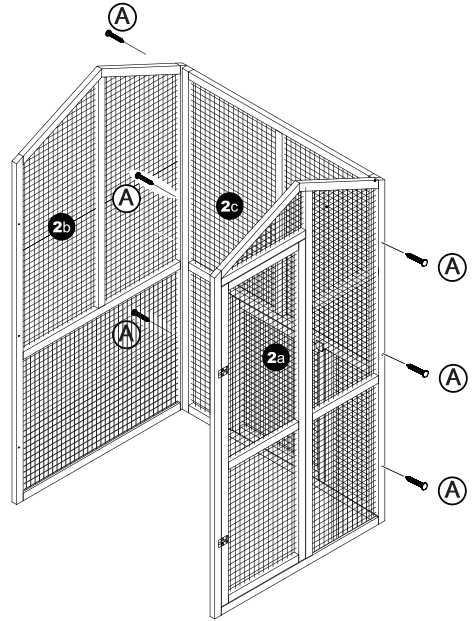

## 3

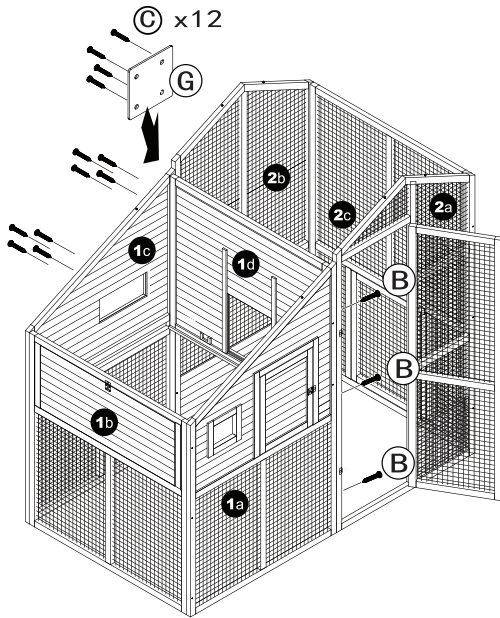

## 4

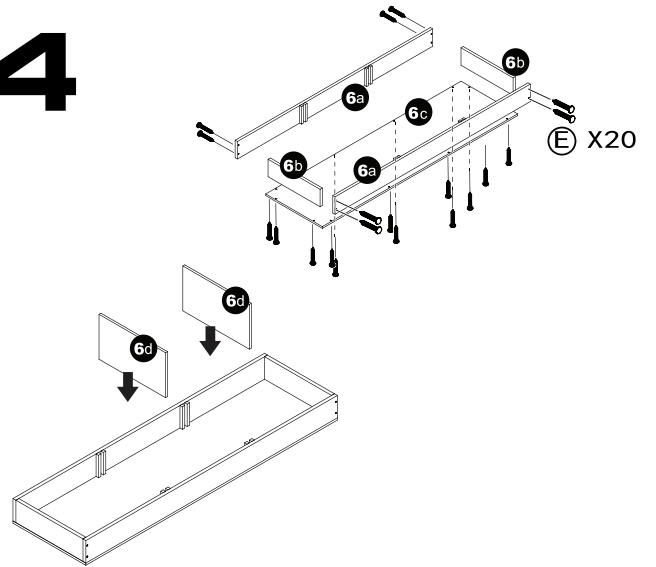

# 5

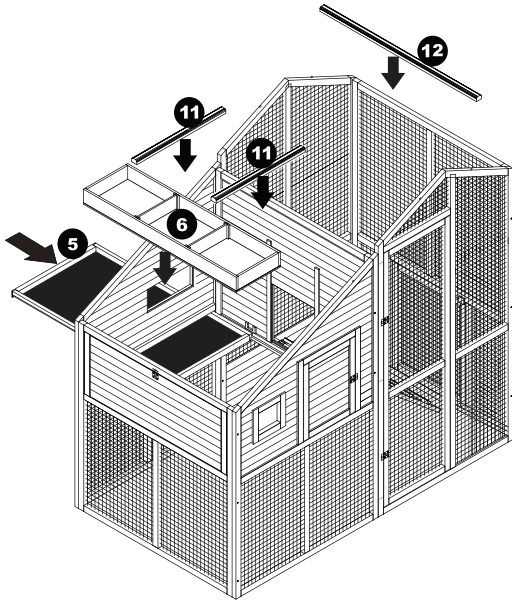

# 6

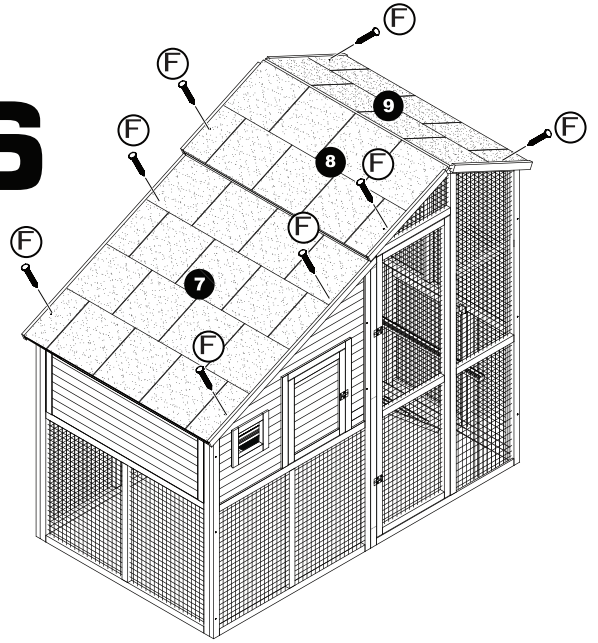

# 7

